

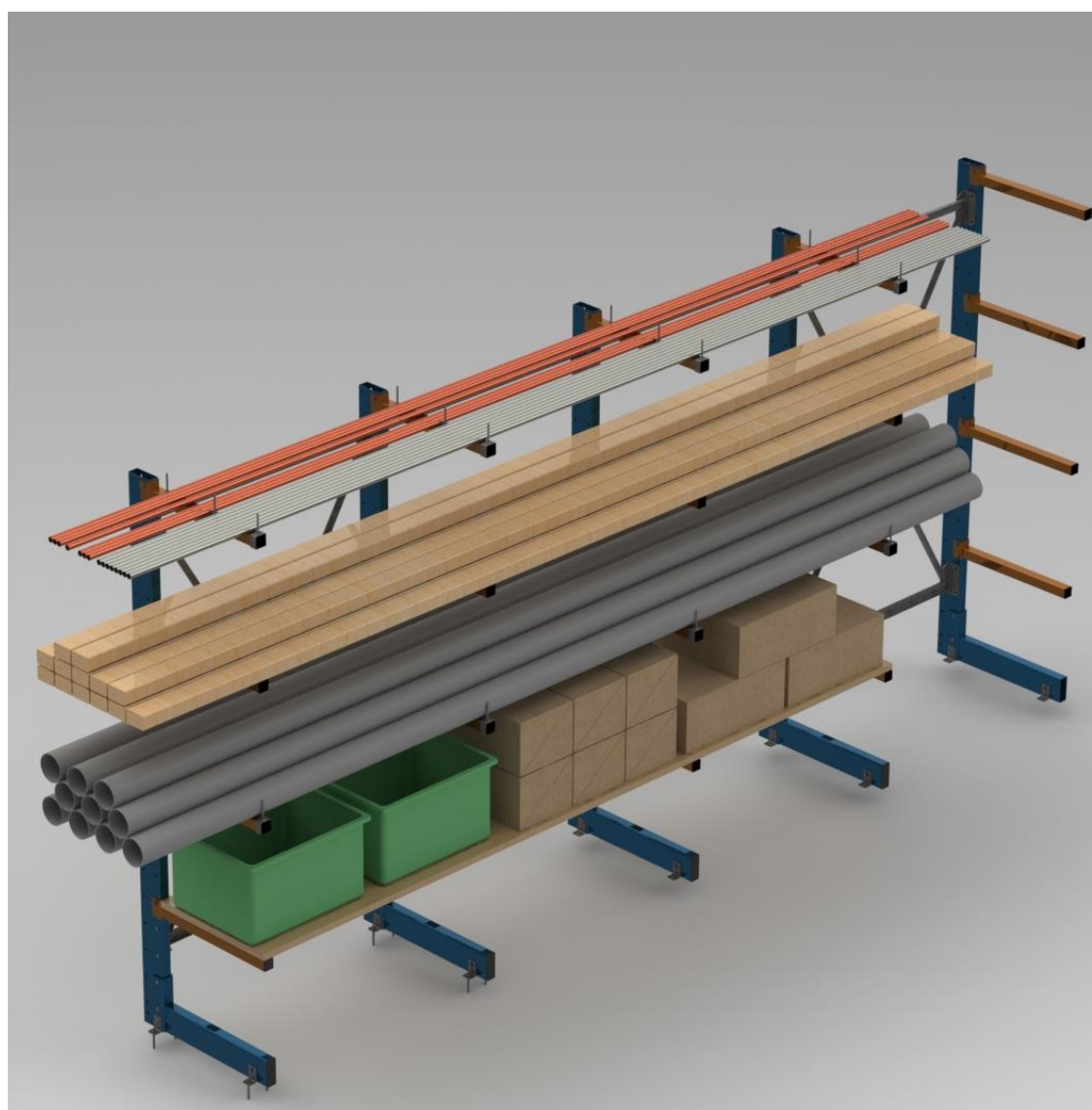

Lichte draagarmstelling
Light cantilever racking
Kragarmregal
Rayonnage cantilever

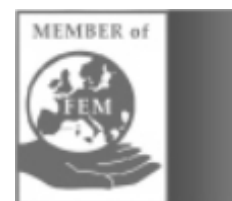

Montage- en gebruikershandleiding
Instructions for assembly and use
Aufbau- und Betriebsanleitung
Instructions de montage et d'utilisation



Overzicht / Survy / Übersicht / Aperçu

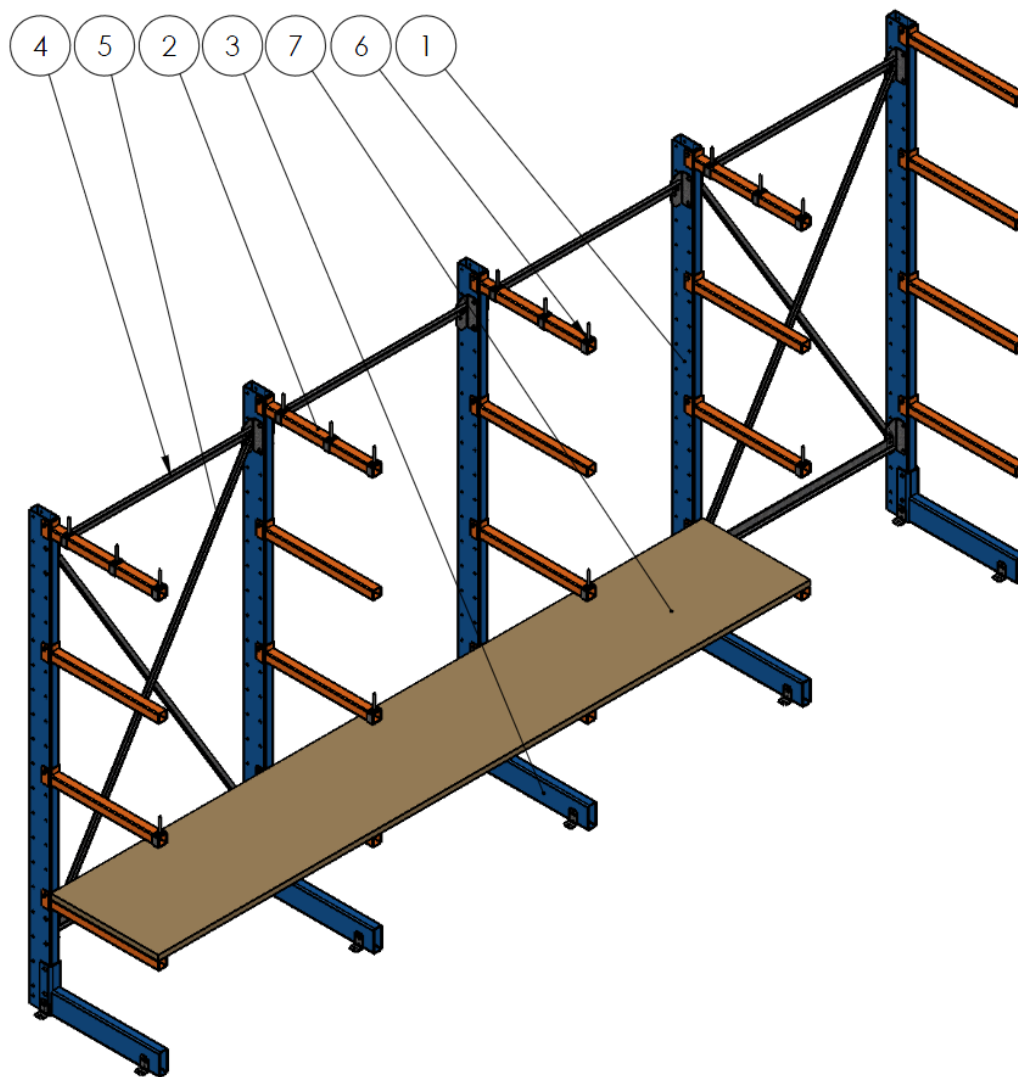

Z

1	Staander Column Ständer Mettre
2	Draagarm Cantilever Kragarm Bras
3	Staandervoet Column feet Ständerfuß Pied
4	Horizontaalschoor Horizontal brace Horizontalverbinder Entretoise
5	Diagonaalschoor Cross bracing Diagonalverband Croisillons de liaison
Accessoires / Accessories / Zubehör / Accessoires	
6	Afolbeveiliging End stop Abrollssicherung Butée
7	Vezelplaat Wooden fibreboard Holz Faserplatten Bois de panneaux de fibres

Inhoud / List of contents / Inhalt / Sommaire

Belangrijke richtlijnen Important regulations Unbedingt beachten Réglémentations importantes	
Normen Design norms Ausführung normen Normes de référence	4
Veiligheidsvoorschriften Accident prevention regulations Sicherheitsvorschriften Consignes de sécurité	4
Vloereigenschappen Flooring Aufstellfläche Qualité du sol	4
Montage Assembly Montage Montage	
Staander & voet Column & feet Ständer & fuß Mettre & Pied	5
Schoring Shoring Sprießung Étayage	7
Draagarmen Cantilevers Kragarmen Bras	9
Verankering Anchoring Verankerung Ancrage	10
Afrolbeveiliging End stop Abrollsicherung Butée	11
Kunststofdop Plastic cap Kunststoffkappe Capuchon en plastique	12
Gebruiksvoorschriften Use specifications Gebrauchsspezifikation spécification d'utilisation	
Belading Loading Beladen Charger	13

Belangrijke richtlijnen / Important regulations / Unbedingt beachten / Réglémentations importantes

Normen
Design norms
Ausführung normen
Normes de référence

- NEN 5052
- NEN 5054
- NEN-EN 15629
- NEN-EN 15635
- Eurocode 0
- Eurocode 1
- Eurocode 3
- Bouwbesluit 2003
- AI 14
- RAL-RG 614
- BGR 234
- Gebruikers dienen rekening te houden met de geldige nationale veiligheidsvoorschriften inzake magazijninrichtingen.
- Users of the installation have to observe the relevant health and safety regulations.
- Benutzer der Installation müssen die relevanten Gesundheits- und Sicherheitsvorschriften kalkulieren.
- En tant que responsable de l'exploitation, veuillez respecter les réglementations de sécurité en vigueur.

Veiligheidsvoorschriften
Accident prevention regulations
Sicherheitsvorschriften
Consignes de sécurité

- | | | | |
|--|---|--|---|
| <ul style="list-style-type: none"> • Stelling dient door deskundig personeel te worden gemonteerd. • Wijzigingen in de stellingconfiguratie mogen enkel na statische berekeningen worden genomen. • Beschadigde onderdelen dienen direct te worden vervangen in overleg met de fabrikant. • Elke stelling dient te zijn voorzien van informatie over de draagvermogen van de stelling. | <ul style="list-style-type: none"> • Stage must be assembled by qualified specialist personnel. • Modifications may only be undertaken after static calculation and clearance by the manufacturer. • Any damaged load-bearing components must be replaced immediately after consultation with the manufacturer. • All racks must be equipped with a notice about load capacity or the installation. | <ul style="list-style-type: none"> • Die Montage muss von qualifiziertem Fachpersonal durchgeführt werden. • Umbauten dürfen nur nach statischer Berechnung und Freigabe vom Hersteller vorgenommen werden • Bei Beschädigung von tragenden Teilen sind diese nach Rücksprache mit dem Hersteller sofort zu ersetzen. • Jedes Regal ist mit Belastungsschildern oder einem Anlagenschild auszustatten. | <ul style="list-style-type: none"> • Le montage doit être effectué par un personnel spécialisé dûment qualifié. • Toute modification ne peut être entreprise qu'après un calcul statique et une autorisation effectués par le constructeur. • En cas d'endommagement de parties portantes, celles-ci doivent être immédiatement remplacées après consultation du constructeur. • Chaque étagère doit être pourvue de panneaux mentionnant la charge ou d'un panneau indicateur. |
|--|---|--|---|

Vloereigenschappen
Flooring
Aufstellfläche
Qualité du sol

Minimum kwaliteit van de betonvloer
Minimum quality of the concrete flooring
Betongüte des Hallenbodens min
Sol de béto d'une qualité minimum de

C20/25 DIN 1045

- Vloeroneffenheden volgens DIN 18202
- For evenness of installation surface see DIN 18202
- Ebenheit des Untergrundes nach DIN 18202
- Planéité du sous-sol selon DIN 18202

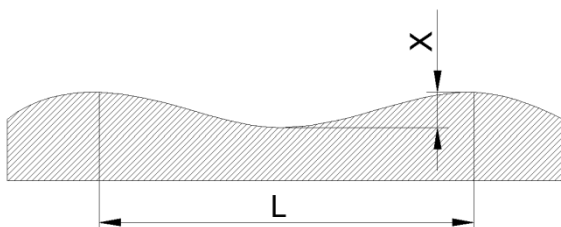

L	X
L < 1m	Max. 4 mm
1m < L < 4m	Max. 10 mm
4m < L < 15m	Max. 12mm
L > 15m	Max. 15mm

1.0 Staander enkelzijdig monteren



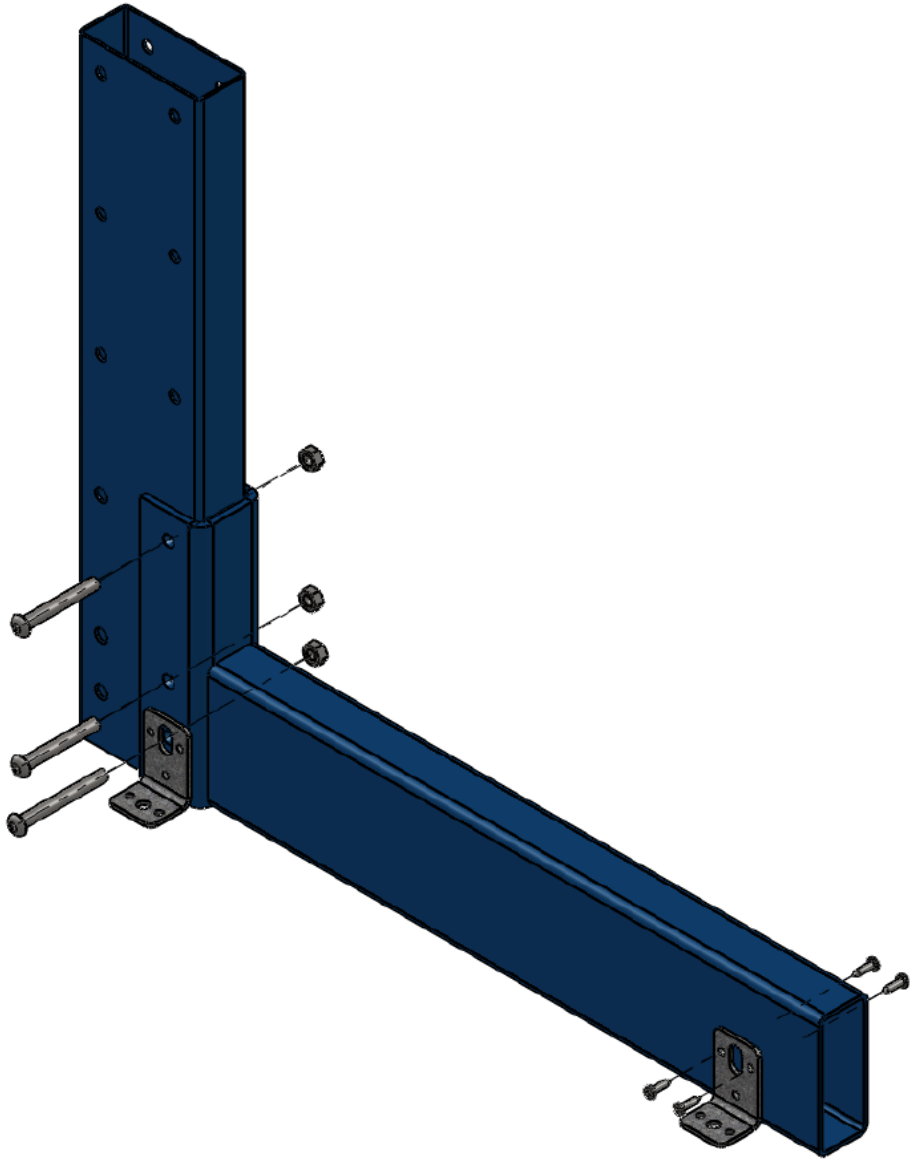

1.0 Bolting one-sided
rack

1.0 Ständer einseitig
verschrauben

1.0 Visser les
montants simples



(1) Indoor rack
(1) Partie intérieure
(1) Lato interno

			
DIN 933/8.8	DIN 934/8.8	DIN 125	
M8x60	M8	Ø 9	25 Nm
M8X70	M8	Ø 9	25 Nm





2.0 Staander dubbelzijdig monteren

2.0 Bolting two-sided rack

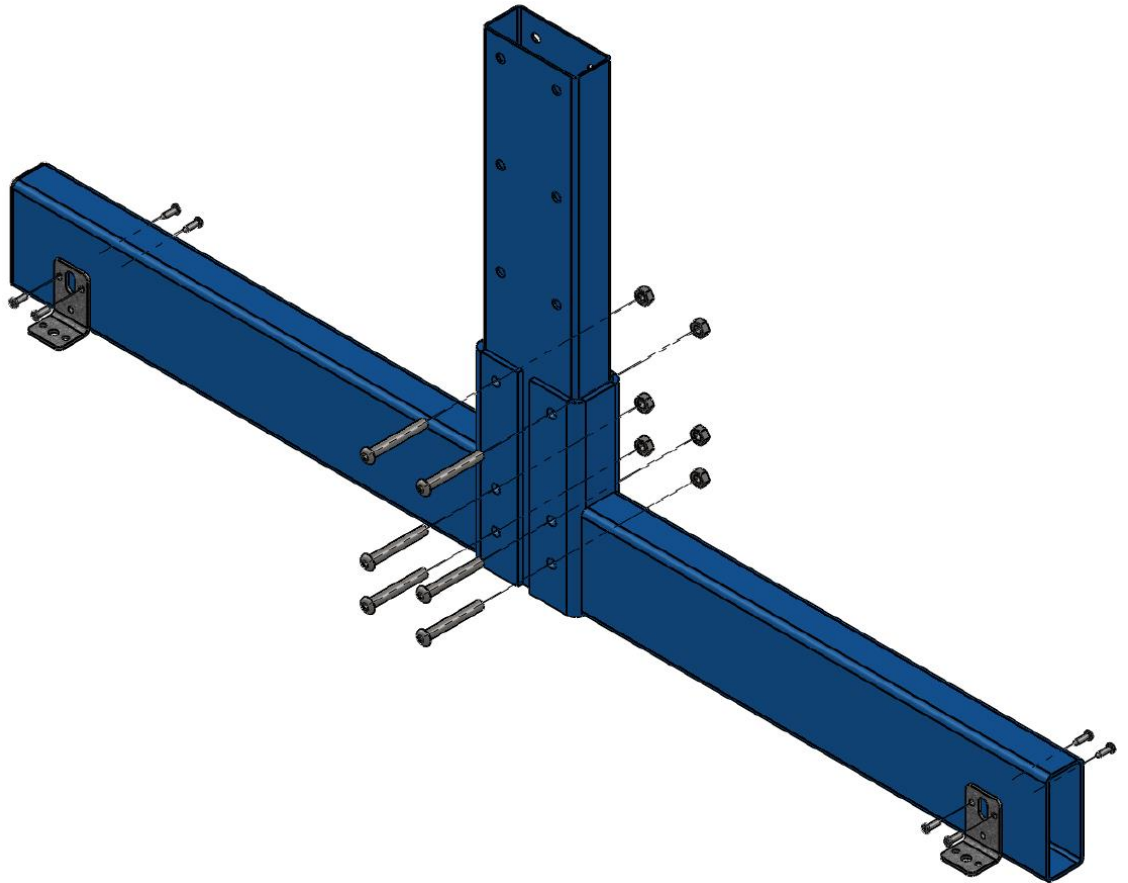
2.0 Ständer zweiseitig verschrauben

2.0 Visser les montants doubles



			
DIN 931/8.8	DIN 934/8.8	DIN 125	
M8X70	M8	Ø 9	25 Nm

- (1) Indoor rack
- (1) Innen Außenbereich
- (1) Partie intérieure





3.0 Schoring montieren

3.0 Assemble horizontal brace

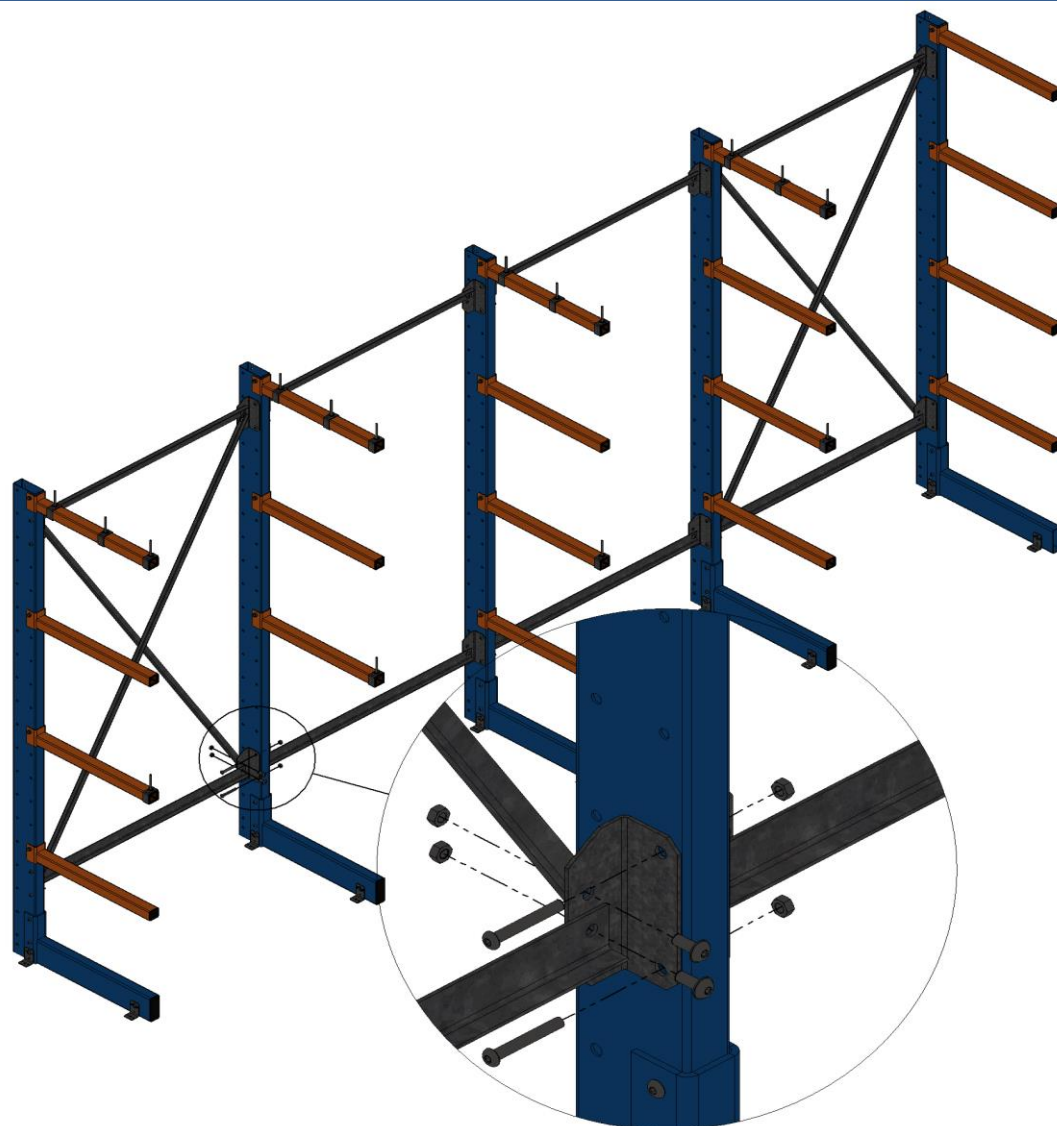
3.0 Verbinder montieren

3.0 Monter entretoise



			
DIN 933/8.8	DIN 934/8.8	DIN 125	
M8X20	M8	Ø 9	25 Nm

4.0 Schoringsplan

4.0 Assemble Cross bracing plan

4.0 Diagonalverband plan

4.0 Monter croisillons de liaison

- Per 3 secties, 1 kruisschoor
- For every 3 bays, 1 cross bracing
- Je 3 Felder, 1 diagonalverband
- Par 3 travées, 1 croisillon

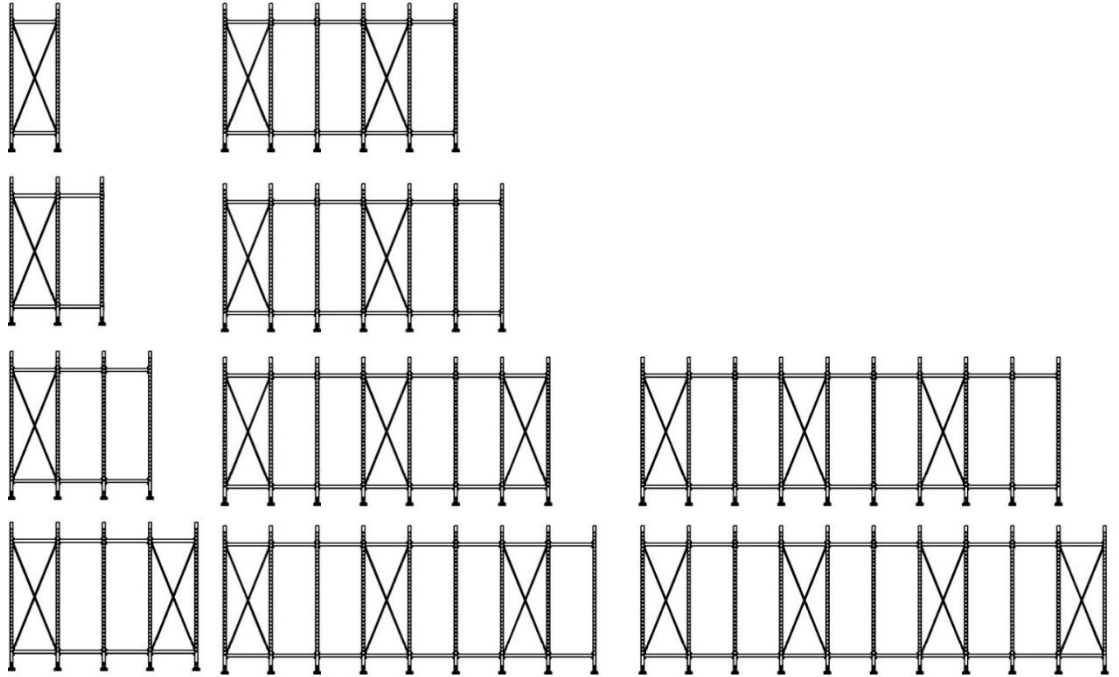





5.0 Draagarmen monteren

5.0 Assembly
Cantilever arm

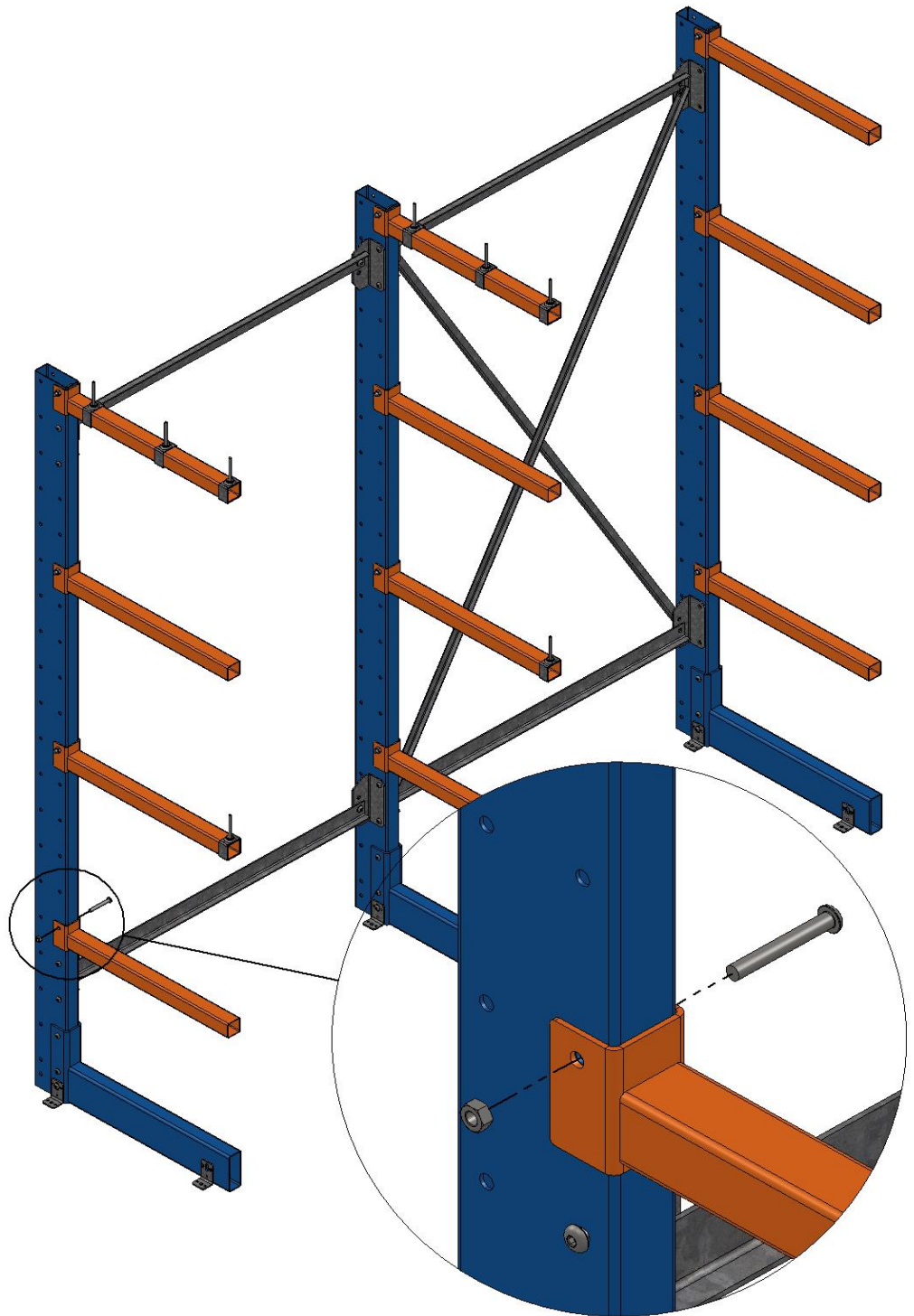
5.0 Einhängen
kragarm

5.0 Emboîter le bras



			
DIN 933/8.8	DIN 934/8.8	DIN 125	
M8X60	M8	Ø 9	25 Nm

6.0 Stelling verankeren

6.0 Verankerung

4 ankers per staandervoet
Optioneel

6.0 Rack anchorage

4 steel anchors per rack foot
Optional



6.0 Verankerung

4 Stahlanker je Ständerfuß
Optionale

6.0 Ancre

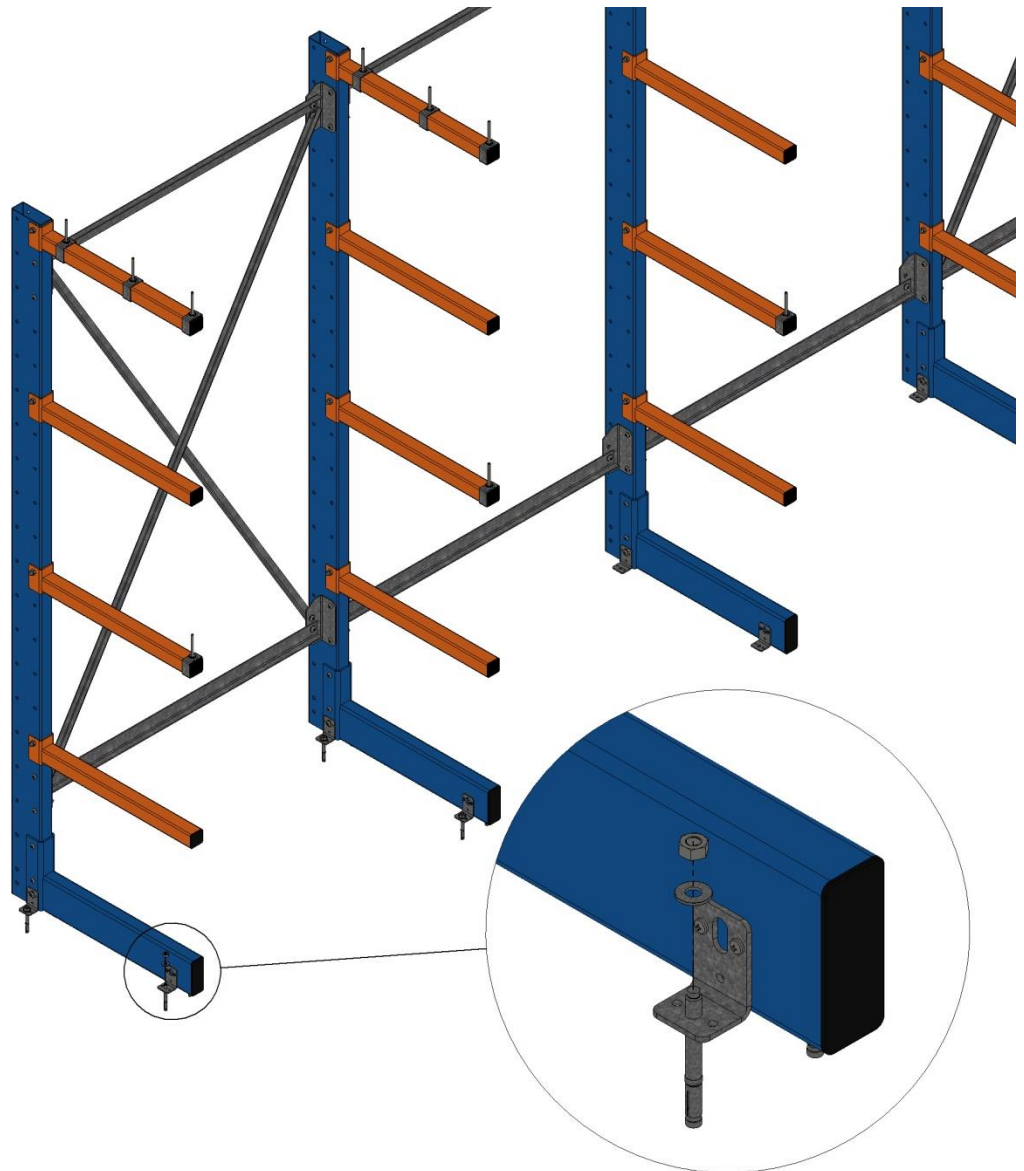
4 ancras en acier par pied de
montant
Optionnel



	M6x60
	ST5,5x19

7.0 Afolbeveiliging

7.0 End stop

7.0 Abrollsicherung

7.0 Butée

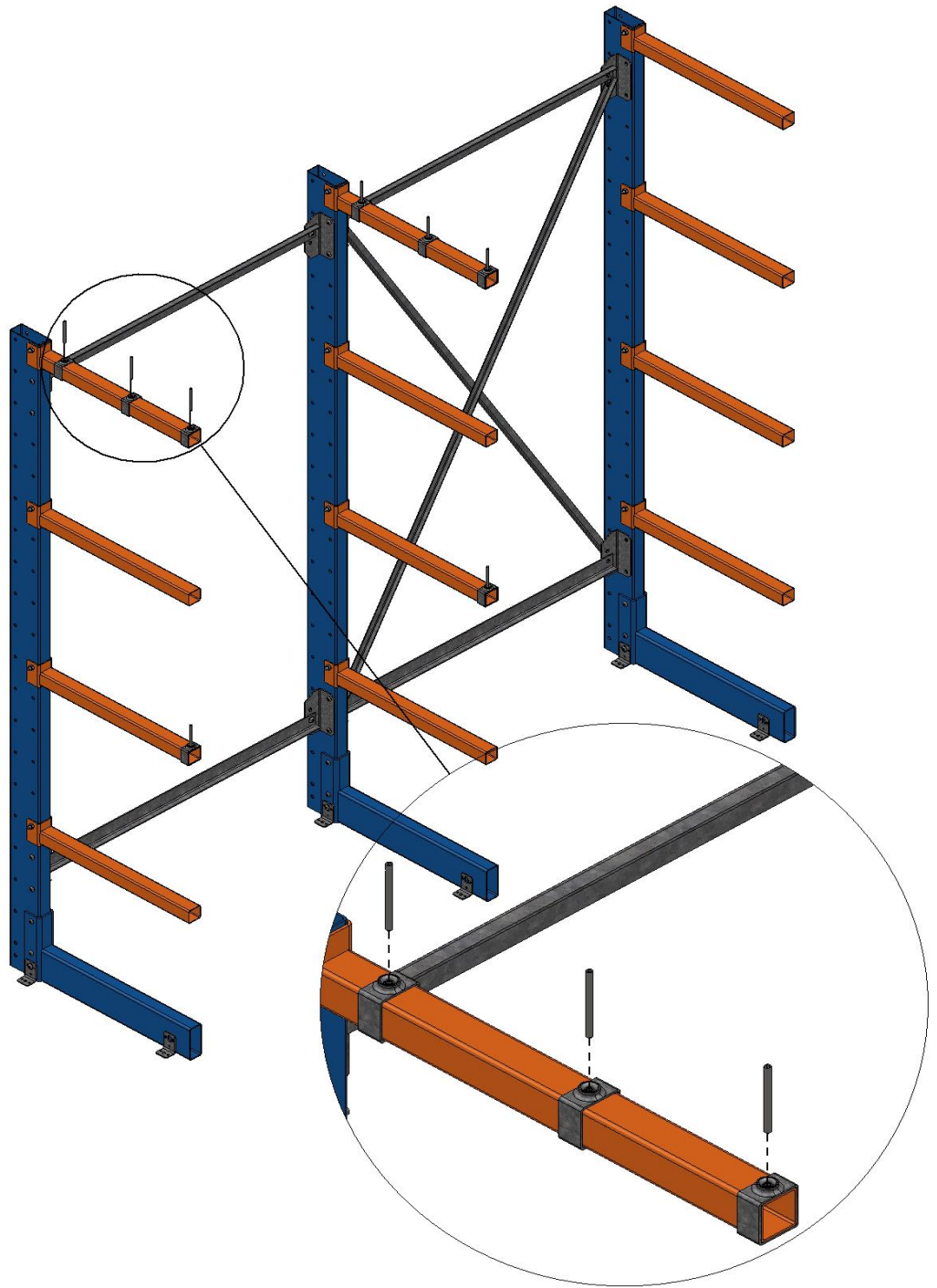

8.0 Eindoppen monteren

8.0 Plastic cap

8.0 Kunststoffkappe

8.0 Capuchon en
plastique

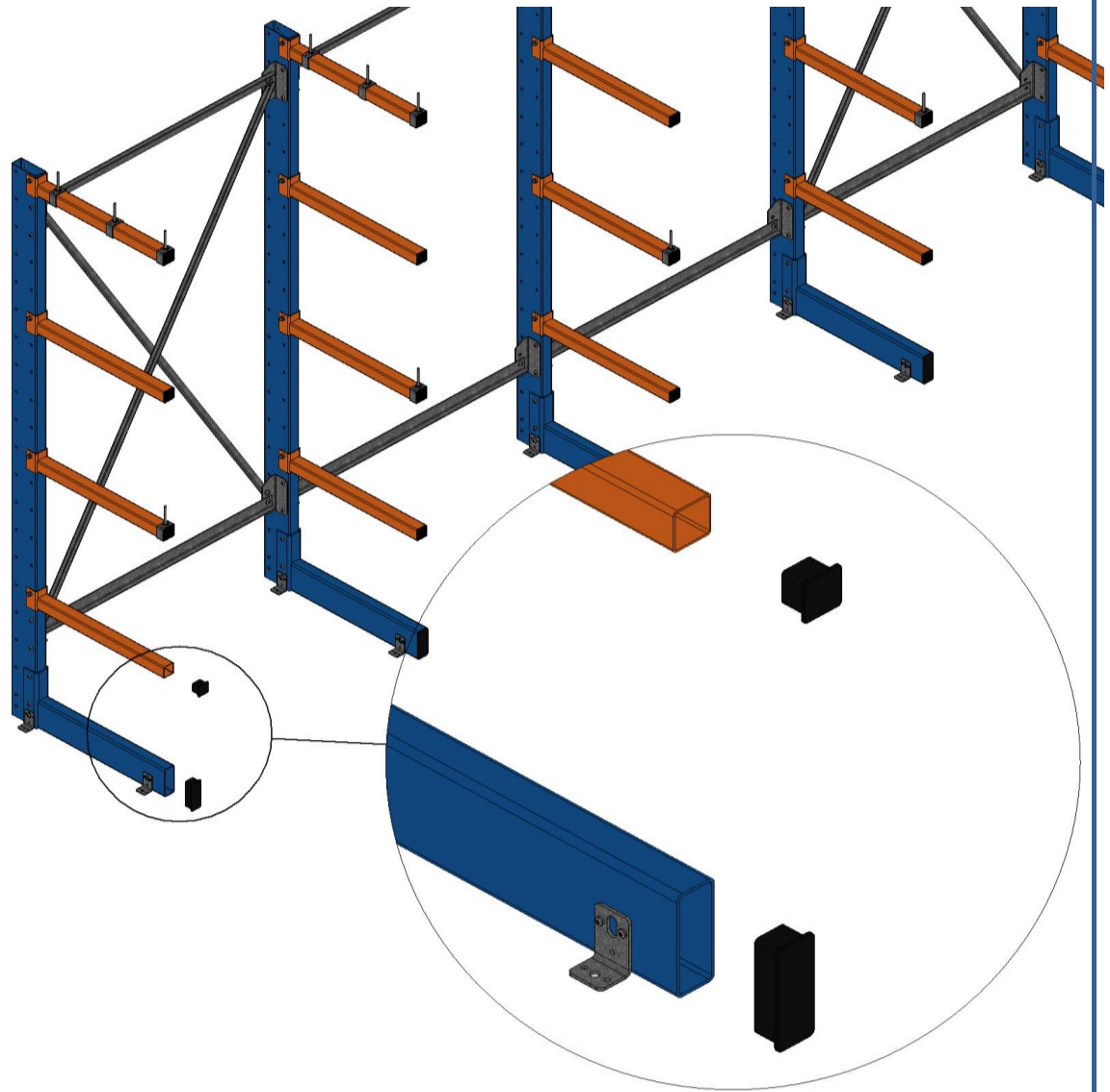

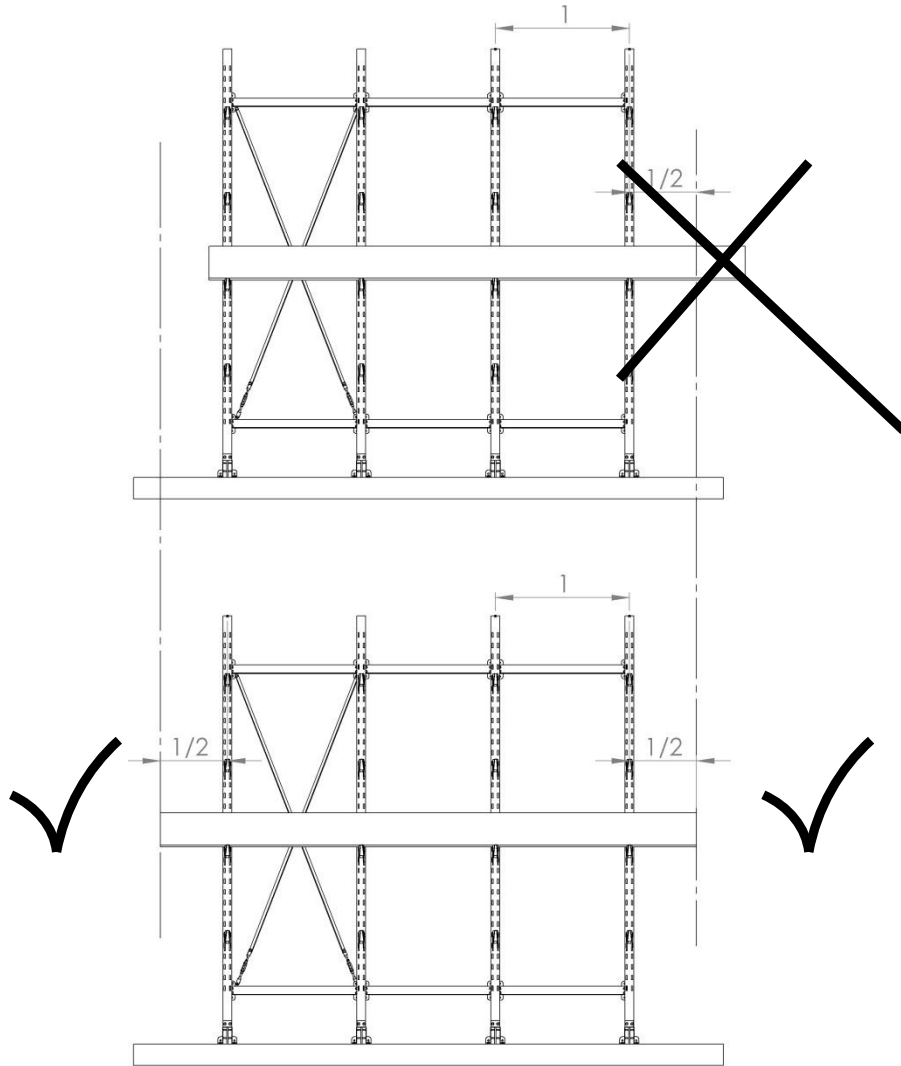

Q= Equal spread load
P= Load per arm
F= Total load

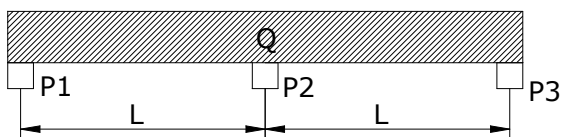

$$P1 = 0,2 Q$$

$$P2 = 0,6 Q$$

$$P3 = 0,2 Q$$

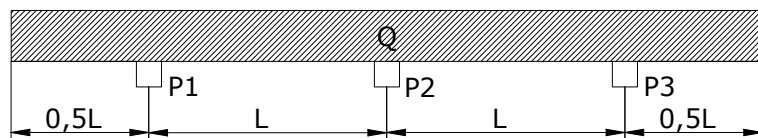

$$P1 = 0,35 Q$$

$$P2 = 0,30 Q$$

$$P3 = 0,35 Q$$

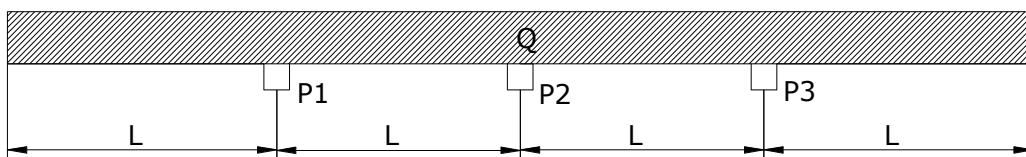

$$P1 = 0,5 Q$$

$$P2 = 0,0 Q$$

$$P3 = 0,5 Q$$

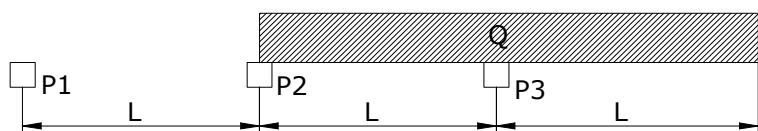

$$P1 = 0,0 Q$$

$$P2 = 0,0 Q$$

$$P3 = 1,0 Q$$